

Form meets Function

Fusion implants by Intra-Lock offer a unique combination of features that have been carefully designed to deliver successful dental implant treatment. The macro-scale form of the implant is designed for stability with Blossom cutting flutes and aggressive threads. With the Ossean nano-scale surface, the biological function of the implant is to promote tissue development for long term performance and stability.¹ The Fusion system is supported by a comprehensive prosthetic portfolio and offers flexibility with guided and free-hand surgical workflows.

- Blossom® redefining cutting technology
- Ossean® surface to induce faster healing¹
- Restorative simplicity and surgical flexibility



The Blossom cutting design allows for the Fusion implants to continually cut through bone with efficiency and minimal force. This minimizes trauma to the tissue, and evenly distributes the cutting force along the full body of the implant. This design functions to lower insertion torque while increasing implant stability and evenly dispersing bone chips along the threads of the implant.² This dispersion helps generate an autologous micro-graft at the implant site, which can promote faster osseointegration.³



The bio-active structure of the Ossean surface is developed by impregnating calcium phosphate into the implant surface, developing a fractal structure that mirrors its design at all levels of magnification.^{4,5,6} This surface can facilitate fibril attachment, platelet deposition and osteoblast development.⁷ These functions can favorably alter the genetic expression of localized cells and induce faster healing of the implants.¹

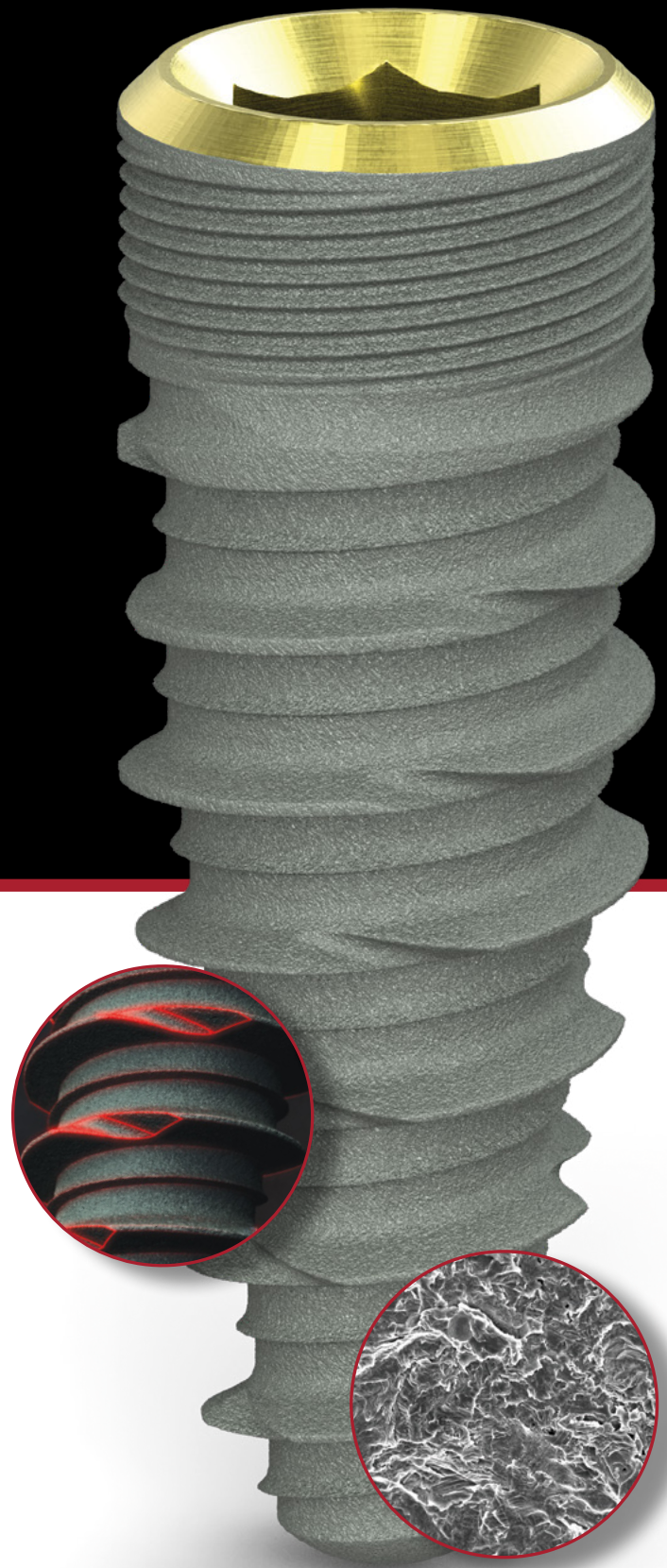

New workflows, more options

Traditional & Guided

The Intra-Lock surgical kit and comprehensive prosthetic portfolio provide an efficient approach to traditional implant protocols. The Intra-Lock Guided kit allows for the use of digital workflows for implant placement and abutment design.



CAD/CAM design

Custom abutments can be designed and customized in a digital plan, and then fabricated at a validated milling center or in-house with a hybrid workflow.



Full-arch solutions

Whether a fixed or removable restoration, partial or full arch, Fusion offers a full range of multi-unit and overdenture abutment options as a solution. Simplified workflows offer ease of use, streamlining even the most challenging indications.

Table of Contents

Introduction	2-3
Fusion Implants	4
Surgical Systems	5
Surgical Components	6
Prosthetic Systems	7
Surgical Protocols	8-9
Implant Placement Level & Spacing	10
Surgical Kit & Drill Sequence	11
Drill Overview	12
Osteotomy Initialization	13
Implant Placement	14-15
Healing Protocols	16
Appendix	17
Icon Legend	18
References	19

FUSION™ IMPLANTS

3.3mmØ Fusion

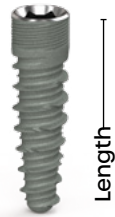

IL-3312

Platform	Product Description	Ref. No.
Grey	Fusion 3.3 x 10.5mm Implant, Grey Platform, Ossean, Blossom	IL-3310
Grey	Fusion 3.3 x 12mm Implant, Grey Platform, Ossean, Blossom	IL-3312
Grey	Fusion 3.3 x 15mm Implant, Grey Platform, Ossean, Blossom	IL-3315

3.8mmØ Fusion

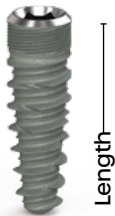

IL-3812

Platform	Product Description	Ref. No.
Grey	Fusion 3.8 x 9mm Implant, Grey Platform, Ossean, Blossom	IL-3809
Grey	Fusion 3.8 x 10.5mm Implant, Grey Platform, Ossean, Blossom	IL-3810
Grey	Fusion 3.8 x 12mm Implant, Grey Platform, Ossean, Blossom	IL-3812
Grey	Fusion 3.8 x 15mm Implant, Grey Platform, Ossean, Blossom	IL-3815

4.2mmØ Fusion

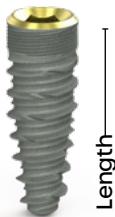

IL-4212

Platform	Product Description	Ref. No.
Yellow	Fusion 4.2 x 9mm Implant, Yellow Platform, Ossean, Blossom	IL-4209
Yellow	Fusion 4.2 x 10.5mm Implant, Yellow Platform, Ossean, Blossom	IL-4210
Yellow	Fusion 4.2 x 12mm Implant, Yellow Platform, Ossean, Blossom	IL-4212
Yellow	Fusion 4.2 x 15mm Implant, Yellow Platform, Ossean, Blossom	IL-4215

5.0mmØ Fusion

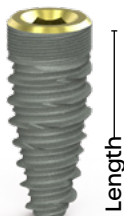

IL-5012

Platform	Product Description	Ref. No.
Yellow	Fusion 5.0 x 7.5mm Implant, Yellow Platform, Ossean, Blossom	IL-5007
Yellow	Fusion 5.0 x 9mm Implant, Yellow Platform, Ossean, Blossom	IL-5009
Yellow	Fusion 5.0 x 10.5mm Implant, Yellow Platform, Ossean, Blossom	IL-5010
Yellow	Fusion 5.0 x 12mm Implant, Yellow Platform, Ossean, Blossom	IL-5012
Yellow	Fusion 5.0 x 15mm Implant, Yellow Platform, Ossean, Blossom	IL-5015

SURGICAL SYSTEMS

Surgical Kit



IL-SK Intra-Lock Surgical Kit

- Color coded workflows for ease of use
- Locking design secures instruments during storage and sterilization
- Implant staging area for implant vials during surgery
- Empty spare slots for additional instruments

Surgical Drills

Tapered Surgical Drills offer efficient cutting flutes for developing clean osteotomies, even in dense bone. Depth marks correspond to the 5 available Fusion implant lengths. Drills should be replaced every 12-20 osteotomies, depending on bone density, for optimal cutting efficiency.



Product Description	Ref. No.
Tapered Surgical Drill, Grey, 2.5mm	TD-25
Tapered Surgical Drill, Purple, 2.8mm	TD-28
Tapered Surgical Drill, Yellow, 3.2mm	TD-32
Tapered Surgical Drill, Green, 3.7mm	TD-37
Tapered Surgical Drill, Red, 4.1mm	TD-41
Tapered Surgical Drill, Blue, 4.5mm	TD-45



Product Description	Ref. No.
Tapered Crestal Bone Drill, Purple, 3.3mm	CBD-33
Tapered Crestal Bone Drill, Yellow 3.8mm	CBD-38
Tapered Crestal Bone Drill, Green, 4.2mm	CBD-42
Tapered Crestal Bone Drill, Blue, 5.0mm	CBD-50

Guided Kit



IL-GK Intra-Lock Guided Kit

For use with a surgical protocol developed by digital planning software. Includes instrumentation required for placement of all Fusion implants.

**Available Q1 2022*

SURGICAL COMPONENTS

Individual Components



Product Description	Ref. No.
Ratchet	R-4MM



Product Description	Ref. No.
Drill Extender	DE-ISO



Product Description	Ref. No.
Ratchet and Hand Wrench Extender	RE-4MM



Product Description	Ref. No.
Hand Wrench	HW-4MM



Product Description	Ref. No.
.050 Hex Driver, Manual	HD-MAN



Product Description	Ref. No.
Straight Parallel Pin	PP-2025



Product Description	Ref. No.
Grey Implant Driver, Handpiece, Regular	ID-GY-ISO
Grey Implant Driver, 4mm Square, Regular	ID-GY-4MM
Yellow Implant Driver, Handpiece, Regular	ID-YW-ISO
Yellow Implant Driver, 4mm Square, Regular	ID-YW-4MM

** Instrument o-rings & c-rings wear out over time. If an instrument is no longer held securely by its associated driver, order a replacement.*

Ancillary Instruments (sold separately)



Product Description	Ref. No.
Pilot Drill, 1.5mm	PD-15
Tapered Surgical Drill, Grey, 2.0mm	TD-20



Product Description	Ref. No.
Bone Profiler, Grey	BP-GY
Bone Profiler, Yellow	BP-YW

Use at implant uncover to remove excess crestal bone for proper abutment seating. Screw the guide into the implant and align the bone profiler for precise bone removal. Match bone profiler and guide color to prosthetic connection.

PROSTHETIC SYSTEMS

Healing Abutments

Narrow, Regular and Wide emergences allow for customization of soft tissue profile during healing. Varying buccal height accommodate for gingival thickness. Hand-tighten with the .050 Hex Driver. Titanium Alloy.



Product Description	Ref. No.
Grey Healing Abutment, Narrow, 3mm Height	HA-GY-N3
Grey Healing Abutment, Narrow, 5mm Height	HA-GY-N5



Product Description	Ref. No.
Grey Healing Abutment, Regular, 3mm Height	HA-GY-R3
Grey Healing Abutment, Regular, 5mm Height	HA-GY-R5



Product Description	Ref. No.
Yellow Healing Abutment, Regular, 3mm Height	HA-YW-R3
Yellow Healing Abutment, Regular, 5mm Height	HA-YW-R5



Product Description	Ref. No.
Yellow Healing Abutment, Wide, 3mm Height	HA-YW-W3
Yellow Healing Abutment, Wide, 5mm Height	HA-YW-W5

Cover Screws

Use during submerged surgical healing. Hand-tighten with the .050 Hex Driver. Titanium alloy. Included with implant but can also be ordered separately



Product Description	Ref. No.
Cover Screw, Grey	CS-GY
Cover Screw, Yellow	CS-YW

SURGICAL PROTOCOLS

This surgical manual serves as a reference for using the Fusion implants and surgical instruments. It is intended solely to provide instructions on the use of Intra-Lock products. It is not intended to describe the methods or procedures for diagnosis, treatment planning, or placement of implants, nor does it replace clinical training or a clinician's best judgment regarding the needs of each patient. Intra-Lock strongly recommends appropriate training as a prerequisite for the placement of implants and associated treatment.

The procedures illustrated and described within this manual reflect idealized patient presentations with adequate bone and soft tissue to accommodate implant placement. No attempt has been made to cover the wide range of actual patient conditions that may adversely affect surgical and prosthetic outcomes. Clinician judgment as related to any specific case must always supersede any recommendations made in this or any Intra-Lock literature.



Before beginning any implant surgical procedure with Intra-Lock implants:

- Read and understand the Instructions for Use that accompany the products.
- Clean and sterilize the surgical tray and instruments per Instructions for Use.
- Become thoroughly familiar with all instruments and their uses.
- Study surgical kit layout and iconography.
- Design a surgical treatment plan to satisfy the prosthetic requirements of the case.



Small diameter implants are intended for the anterior region of the mouth and are not intended for the posterior region of the mouth due to possible failure of the implant.

Indications

Intra-Lock implants are intended for use in the mandible or maxilla for use as an artificial root structure for single tooth replacement or for fixed bridgework and dental retention. The implants may be restored immediately:

- (1) with a temporary prosthesis that is not in functional occlusion
- (2) when splinted together for multiple tooth replacement or when stabilized with an overdenture supported by multiple implants

Intra-Lock 3.3mm diameter implants may be used as an artificial root structure for single tooth replacement of mandibular central and lateral incisors and maxillary lateral incisors. The implants may be restored immediately:

- (1) with a temporary prosthesis that is not in functional occlusion
- (2) when splinted together as an artificial root structure for multiple tooth replacement of mandibular incisors
- (3) for denture stabilization using multiple implants in the anterior mandible and maxilla.

The implants may be placed in immediate function when good primary stability has been achieved and with appropriate occlusal loading.

SURGICAL PROTOCOLS

Two-Stage Protocol

In a two-stage surgery, the implant is placed below the soft tissue and protected from occlusal function and other forces during osseointegration. A low-profile cover screw is placed on the implant to protect it from the ingress of soft tissue.

Following osseointegration, a second procedure exposes the implant and a transmucosal healing abutment is placed to allow for soft tissue healing and development of a sulcus. Prosthetic restoration begins after soft tissue healing.

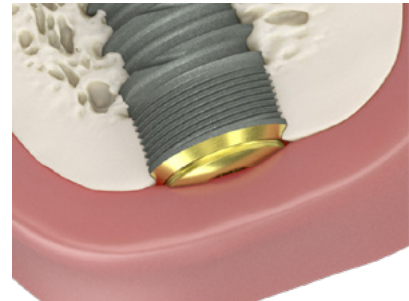

Implant with cover screw in a two-stage protocol.

Single-Stage Protocol

Single-stage surgery may be accomplished by placing a healing abutment at the time of implant surgery. This eliminates the need for a second procedure. Although the implant is not in occlusal function, some forces can be transmitted to it through the exposed transmucosal element.

Prosthetic restoration begins following osseointegration of the implant and soft tissue healing.

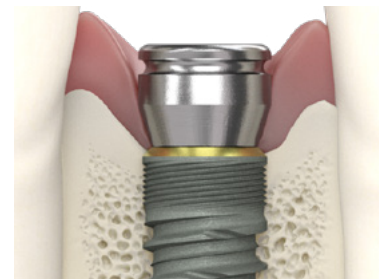

Implant with healing abutment in a single-stage protocol.

Non-functional Immediate Restoration

Single-stage surgery with non-functional immediate provisionalization provides the patient a non-functioning provisional prosthesis early in the treatment plan. An abutment is placed on the implant at or shortly after surgery, and a provisional restoration is secured using temporary cement. The provisional can help contour the soft tissue profile during healing.



Implant restored with a non-functional provisional prosthesis.

Immediate Function Restoration

Single-stage surgery with immediate function is possible in good quality bone where multiple implants exhibiting excellent initial stability can be splinted together. Splinting implants together may offer a biomechanical advantage over individual, unsplinted prostheses.



Implants with a splinted prosthesis in immediate function.

IMPLANT PLACEMENT LEVEL & SPACING

Implant-to-Tooth Spacing

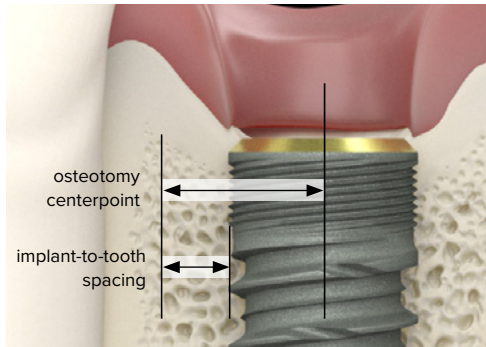

The osteotomy centerpoint required to maintain a specific implant-to-tooth spacing is calculated according to this formula:

$1/2$ (implant body diameter) + the desired spacing.



During implant placement, clinicians must apply their best judgment as to the appropriate spacing for individual patient conditions.

Implant-to-Implant Spacing

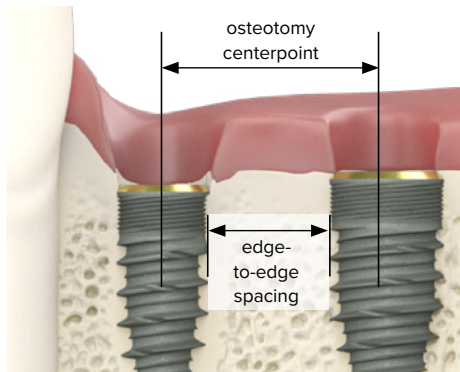

The osteotomy center-to-center measurement required to maintain a specific edge-to-edge spacing between two implants is calculated according to this formula:

$1/2$ (sum of 2 implant body diameters) + the desired spacing.



During implant placement, clinicians must apply their best judgment as to the appropriate spacing for individual patient conditions.

SURGICAL KIT & DRILL SEQUENCE

Surgical Kit Instructions

The surgical kit uses an intuitive layout to guide the surgeon through the instrument sequence. The sequence begins in the upper left hand corner and works left-to-right and then down if a crestal bone drill is being used. Prior to use, clean and sterilize the surgical tray and instruments according to the Instructions for Use included with the kit. Study the surgical kit layout, color coding and iconography. Surgical assistants should be thoroughly familiar with all instruments and their uses prior to initiating the surgical procedure.

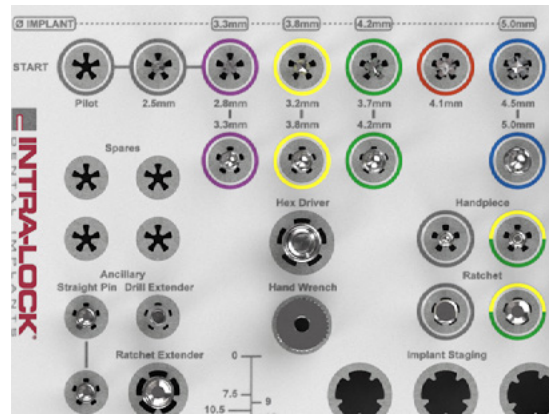

Tapered Surgical drills increase in diameter as you work through the sequence from left-to-right.

The implant driver section is color-coded by prosthetic platform (grey or yellow).

Drill Sequence

3.3mm body diameter	2.5	2.8	3.2	3.7	4.1	4.5	
3.8mm body diameter							
4.2mm body diameter							
5.0mm body diameter							
HD Drill Sequence							Implant Driver
Recommended speed 1,500 - 2,000 RPM			Recommended speed 1,000 RPM				Maximum 30 RPM or use manually
Initiate osteotomy			Develop osteotomy				Place implant matching the length of the prepared osteotomy

Note: The 2.8mm drill is used for the 3.3mm diameter implant; it is not needed for other sizes.

DRILL OVERVIEW

Drill Markings

All surgical drills included with this system are externally irrigated and designed to be used with steady sterile irrigation. Reduced drill speed may be indicated in softer bone or as drill diameter increases.

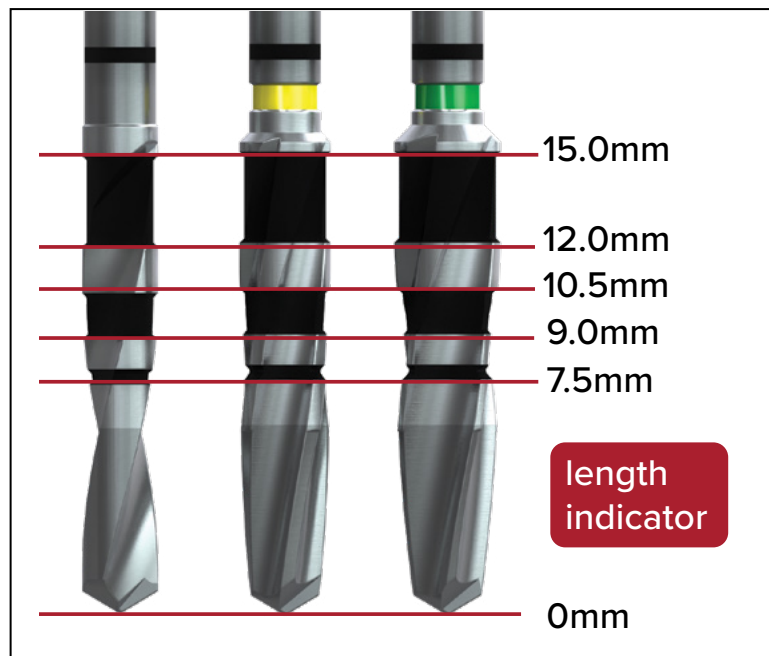

Note: The depth marks are consistent throughout the starter drills and width increasing drills

Important Considerations

- Peri-operative oral rinses with a 0.12% Chlorhexidine Digluconate solution have been shown to significantly lower the incidence of post-implantation infectious complications.⁸ A pre-operative 30-second rinse is recommended, followed by twice daily rinses for two weeks following surgery.
- Drilling must be done under a constant stream of sterile irrigation. A pumping motion should be employed to prevent over-heating the bone. Surgical drills and taps should be replaced when they are worn, dull, corroded or in any way compromised. Intra-Lock recommends replacing drills after 12 to 20 osteotomies.⁹ A Drill-usage Tracking Chart is available at intra-lock.com to record this important information.
- There is a risk of injury to the mandibular nerve associated with surgical drilling in posterior mandibular regions. To minimize the risk of nerve injury, it is imperative that the clinician understands the drill depth markings as they relate to the implant length to produce the desired vertical placement of the implant.

OSTEOTOMY INITIALIZATION

Pilot Drill (optional)



- Purpose: Initiate osteotomy.
- Efficient cutting drill design for cortical plate
 - Matte finish for increased visibility
 - 1,500 - 2,000 RPM

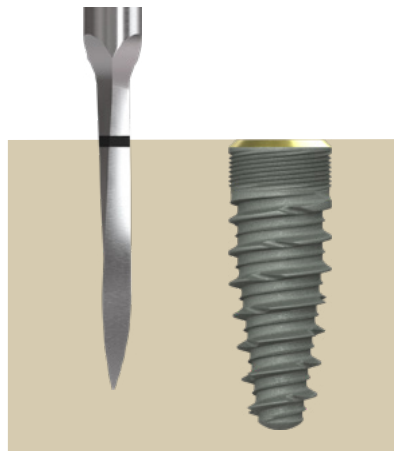

The pilot drill is designed to initiate the osteotomy.

2.5mm Surgical Drill



- Purpose: Set osteotomy depth.
- Efficient cutting drill design collects bone for autografting
 - Matte finish for increased visibility under operatory lights
 - 1,500 - 2,000 RPM

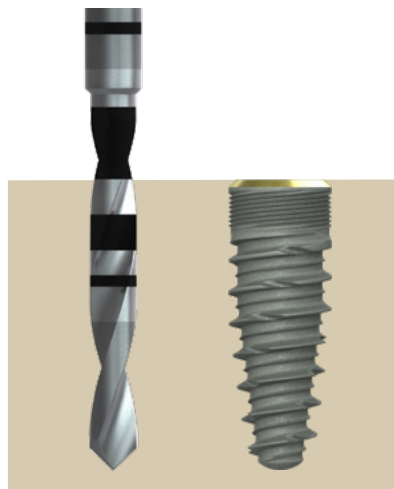

The 2.5mm depth drill is designed to increase and/or set the depth of the osteotomy.

Paralleling Pins



- Purpose: Evaluate osteotomy position
- Use after 2.0mm or 2.5mm Tapered Surgical Drill
 - 9mm shank for radiographic evaluation of proximity to adjacent anatomy
 - Hub diameter is 4.0mm



IMPLANT PLACEMENT

Surgical Drills



- Purpose: Incrementally widen the osteotomy to reduce heat generation.
- Depth-marked for reference
 - Efficient cutting drill design collects bone for autografting
 - The drill tip has limited end cutting. However, the osteotomy depth can be increased with these drills as needed
 - Matte finish for increased visibility under operator lights
 - Final Drill color coded by implant body diameter (purple = 3.3mm, yellow = 3.8mm, green = 4.2mm, blue = 5.0mm)
 - 1,000 RPM

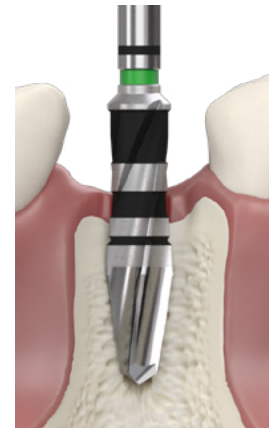

Crestal Bone Drills



- Purpose: Remove cortical bone at ridge crest for pressure-free seating of the implant collar.
- Use when dense cortical bone is present at crest
 - Rounded non-end cutting hub centers drill in osteotomy
 - Color coded by implant body diameter (purple = 3.3mm, yellow = 3.8mm, green = 4.2mm, blue = 5.0mm)
 - Use following the final width increasing drill for each implant
 - 1,000 RPM

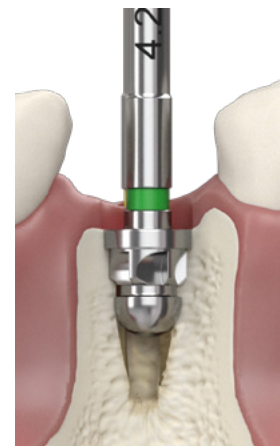

Implant Drivers



- Purpose: Engage the implant's internal hex to drive implants into the osteotomy.
- Implant level drivers are color-coded by prosthetic connection:
 - grey
 - yellow/green
 - 30 rpm or less¹⁰

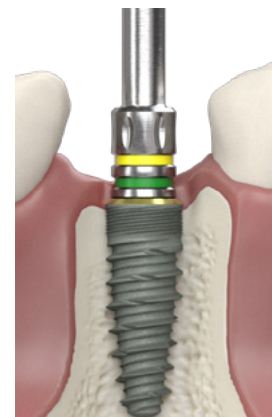

IMPLANT PLACEMENT

Implant Pick-up

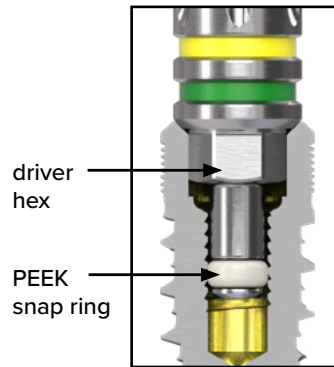

To pick-up the implant, align the driver hex with the implant hex and press firmly to engage the PEEK snap ring.

Implant Placement

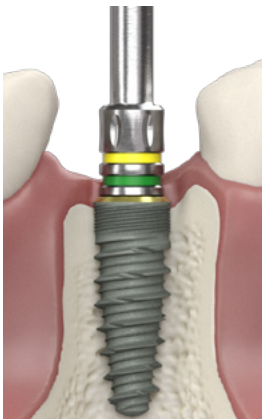

Place the apex of the implant into the osteotomy and begin rotating slowly. The driver hex will engage when the driver is slowly rotated under apical pressure.



If too much resistance is felt during insertion, reverse the implant to relieve pressure and re-insert into the osteotomy. If the crestal bone drill was not used while preparing the osteotomy, remove the implant and revise the osteotomy with the crestal bone drill.

Internal Hex Orientation

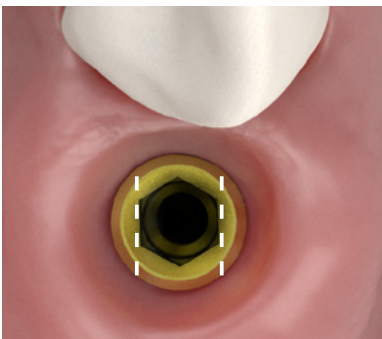

When seating the implant, use the corresponding dimples on the driver to orient one internal hex flat perpendicular to the implant angulation plane. Doing so verifies that an angled abutment will correct the angulation.

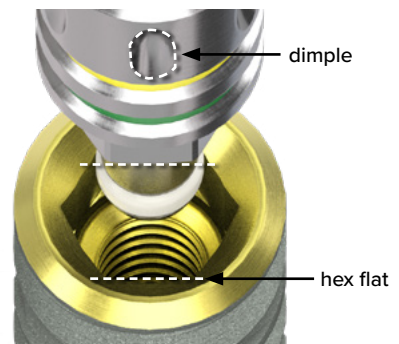

HEALING PROTOCOLS

Cover Screws for Two-stage Protocol



Purpose: Protects prosthetic platform in two-stage (submerged) surgical protocol for bone level implants.

- Irrigate implant to remove blood and other debris:
- Use an antibacterial paste to decrease the risk of bacterial growth
- Thread clockwise into implant body
- Color-coded by prosthetic platform
- Hand-tighten (10-15 Ncm) utilizing .050" (1.25mm) Hex Driver

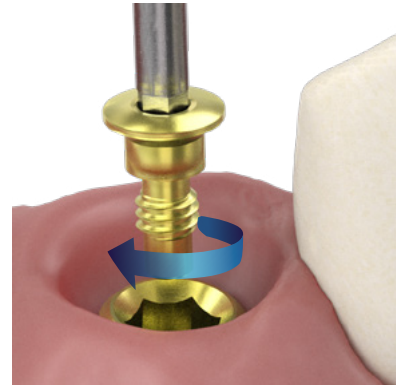

cover screw

The cover screw for the implant is mounted in the vial cap.

Healing Abutments for Single-stage Protocol



Purpose: Transmucosal element for developing soft tissue emergence with narrow, regular, wide emergence.

- Color-coded by prosthetic platform
- The 3.5mm healing abutment is laser marked for easy intraoral identification; for example: YR3=Yellow (3.5mm) platform / Regular Emergence / 3mm High
- Hand-tighten (10-15 Ncm) utilizing .050" (1.25mm) Hex Driver



Immediate Provisional Restorative Options



Temporary Abutments

Purpose: Titanium and PEEK temporaries are easily modified for fabrication of cement or screw-retained provisional restorations. A long direct coping screw (purchased separately) may be used to maintain the screw access hole during the fabrication of a screw-retained provisional prosthesis.

APPENDIX

Bone Profilers



Purpose: In cases where excess crestal bone has been created, use a bone profiler at implant uncover to contour the bone. This will provide the necessary clearance for proper abutment seating.

- Profiler guide protects implant platform
- Color-coded by prosthetic platform (grey or yellow)
- 800 rpm drill speed with steady sterile irrigation

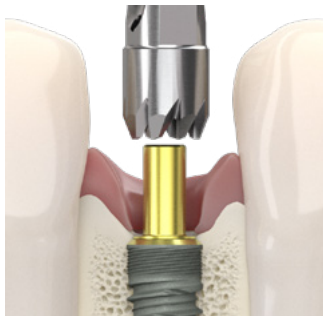

Do not use the profiler without the guide in place.

Using an .050" hex driver, remove the surgical cover screw from the implant and place the profiler guide that matches the color of the implant prosthetic platform. Use the profiler with copious amounts of sterile irrigation. Once the excess bone and soft tissue are removed, unscrew the guide and seat the appropriate prosthetic component.

Post-operative Instructions

A period of unloaded healing time is often recommended to allow for integration between the bone and implant surface. This is dependent on individual patient healing rates and bone quality of the implant site. Each case must be independently evaluated.

The patient should be instructed to follow a post-surgical regimen including cold packs for 24 hours post-implantation. The patient's diet should consist of soft foods and possibly dietary supplements. Pharmacological therapy should be considered as the patient's condition dictates.

If a removable prosthesis is used during the initial healing phase, a soft liner material should be used to prevent pressure on the surgical site. Relieve the prosthesis over the implant site prior to the soft liner application. Periodically check the patient's soft tissue and bone healing using clinical and radiographic evaluations.

Ongoing hygiene for the implant patient is vital. Hygiene recall appointments at three month intervals are suggested. Instruments designed for implant abutment scaling, such as Implacare® instruments from Hu-Friedy® should be utilized. The stainless steel handles may be fitted with assorted tip designs for hygiene on natural teeth. The Implacare® scalers contain no glass or graphite fillers that can scratch titanium implant abutments.

ICON LEGEND

Symbol Descriptions for Product Labeling

REF Reference/article number

LOT Lot/batch number

Use before expiration date (YYYY-MM-DD)

Manufacture date (YYYY-MM-DD)

STERILE R Sterile by gamma irradiation

NON-STERILE Non-sterile

Label number

Single use only

Caution: Indicates the need for the user to consult the instructions for use for important cautionary information such as warnings and precautions that cannot, for a variety of reasons, be presented on the medical device itself.

Rx Only Caution: Federal (USA) law restricts these devices to the sale, distribution and use by, or on the order of, a dentist or physician.

CE 2797 Intra-Lock products carry the CE mark and fulfill the requirements of the Medical Devices Directive 93/42/EEC. For Class I unchanged devices, EU Medical Device Regulations 2017/745 applies.

EU Authorised Representative
Altatec GmbH
Maybachstrasse 5
71299 Wimsheim
Germany
TEL +49.7044.94450

Fusion Product Labeling



body diameter	prosthetic platform
3.3mm	grey (3.0mm internal hex & cover screw)
3.8mm	grey (3.0mm internal hex & cover screw)
4.2mm	yellow (3.5mm internal hex & cover screw)
5.0mm	yellow (3.5mm internal hex & cover screw)

REFERENCES

1. Nanometer-Scale Features on Micrometer-Scale Surface Texturing: A bone Histological, Gene Expression, and Nano Mechanical Study
Paulo G. Coelho, Tadahiro Takayama, Daniel Yoo, Ryo Jimbo, Sanjay Karunagaran, Nick Tovar, Malvin N. Janal, Seiichi Yamano. *Bone*, Issue 65, Aug. 2014.
2. The effect of implant design on insertion torque and immediate micromotion
Amilcar C. Freitas Jr, Estevam A. Bonfante, Gabriela Giro, Malvin N. Janal, Paulo G. Coelho
Clin. Oral Impl. Res. 10.1111/j. 1600-0501.2010.02142.x c_ 2011 John Wiley & Sons A/S
3. On osseointegration
R. Jimbo, N. Tovar, C. Marin, H. S. Teixeira, R. B. Anchieta, L. M. Silveira, M. N. Janal, J. A. Shibli, P. G. Coelho:
Int. J. Oral Maxillofac. Surg. 2014; xxx: xxx-xxx. In-Press # 2014 International Association of Oral and Maxillofacial Surgeons. Published by Elsevier Ltd.
4. Identification card and codification of the chemical and morphological characteristics of 14 dental implant surfaces.
David Marcel Dohan Ehrenfest, DDS, MS, PhD, Lydia Vazquez, Yeong-Joon Park, Gilberto Sammartino, and Jean-Pierre Bernard Chonnam
National University School of Dentistry, LoB5 unit, School of Dentistry, Gwangju, South Korea *Journal of Oral Implantology*: October 2011, Vol. 37, No. 5, pp. 525-542
5. Classification of Osseointegrated Implant Surfaces: Materials, Chemistry and Topography
David M. Dohan Ehrenfest, Paulo G. Coelho, Byung-Soo Kang¹, Young-Taeg Sul¹ and Tomas Albrektsson
1 Trends Biotechnol. 2010 Apr;28(4):198-206. Epub 2010 Jan 29.
6. Basic Research Methods and Current Trends of Dental Implant Surfaces
Paulo G. Coelho, Jose M. Granjeiro, George E. Romanos, Marcelo Suzuki, Nelson R. F. Silva, Giuseppe Cardaropoli, Van P. Thompson, Jack E. Lemons
J Biomed Mater Res B Appl Biomater. 2009 Feb;88(2):579-96. doi: 10.1002/jbm.b.31264.
7. Histomorphometric Evaluation of Bioceramic Molecular Impregnated and Dual Acid-Etched Implant Surfaces in the Human Posterior Maxilla
Jamil Awad Shibli, DDS, MS, PhD; Sauro Grassi, DDS, MS; Adriano Piattelli, MD, DDS;
Gabriele E. Pecora, MD, DDS; Daniel S. Ferrari, DDS, MS; Tatiana Onuma, DDS; Susana d'Avila, DDS, MS, PhD;
Paulo G. Coelho, DDS, PhD; Raquel Barros, DDS, MS; Giovanna Iezzi, DDS, PhD
Clinical Implant Dentistry and Related Research. Published Online: 28 Apr 2009 in Wiley Inter Science
© 2010 Wiley Periodicals, Inc.
8. The influence of 0.12 percent chlorhexidine digluconate rinses on the incidence of infectious complications and implant success.
Lambert PM, Morris HF, Ochi S. *J Oral Maxillofac Surg* 1997;55(12 supplement 5):25-30.
9. Heat production by 3 implant drill systems after repeated drilling and sterilization.
Chacon GE, Bower DL, Larsen PE, McGlumphy EA, Beck FM. *J Oral Maxillofac Surg.* 2006 Feb;64(2):265-9.
10. Root Form Surgery in the Edentulous Mandible: Stage I Implant Insertion.
CE Misch. *Contemporary Implant Dentistry Second Edition*. Mosby: St. Louis, 1999. 347-369.



Intra-Lock®, Ossean® and Blossom® are Registered Trademarks of BioHorizons
Fusion is a Trademark of BioHorizons